

# SAFARI 1D1W

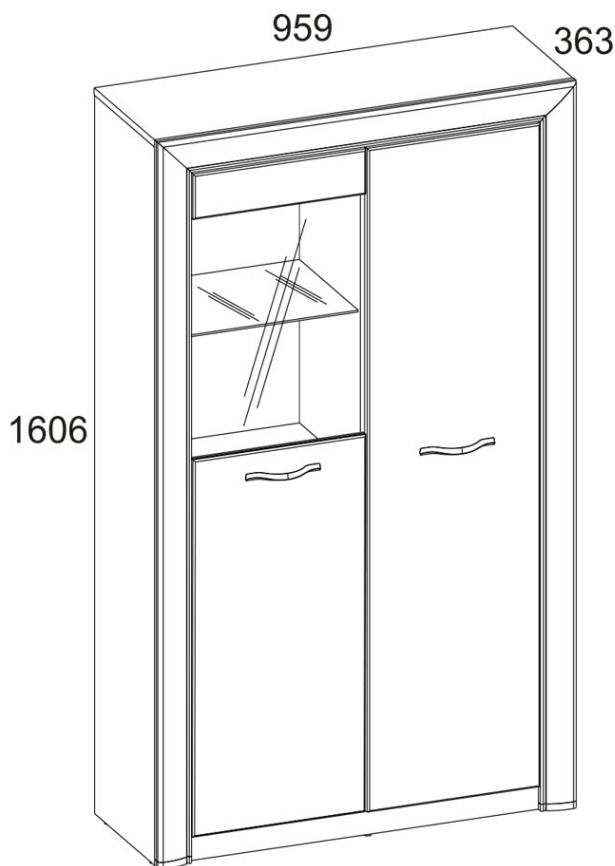

Kód	L, mm	B, mm	H, mm		baliček
1	958	335	16	1	1/2
2	924	335	16	1	1/2
3	454	335	16	1	1/2
4	454	335	16	1	1/2
5	452	325	6	1	1/2
6	452	335	16	3	1/2
7	1585	335	16	1	2/2
8	1585	335	16	1	2/2
9	1514	335	16	1	2/2
10	924	55	16	2	1/2
11	1464	396	16	1	2/2
13	1464	396	16	1	2/2
15	1587	80	25	1	2/2
16	1587	80	25	1	2/2
17	959	80	25	1	2/2
18	1540	475	2,5	1	2/2
19	1540	475	2,5	1	2/2

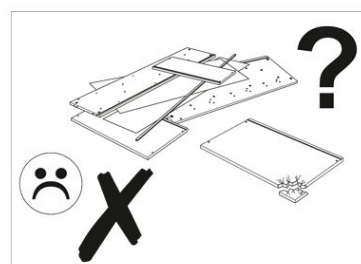

Při používání nábytku je ZAKÁZÁNO:

- umisťovat nábytek do blízkosti topných zařízení a vlhkých zdí, taktéž do místností s relativní vlhkostí vyšší než 70 %;
- teplota ohřevu nábytkových prvků nesmí překročit + 40 °C;
- při montáži a používání nábytku stůjte nohama na vodorovných panelech a oknech;
- k čištění nábytku používat chemické čisticí prostředky;
- neměly by být vystaveny vodě.

Vůně.

Nový nábytek může vydávat vůni materiálů, ze kterých je vyroben. Vůně může přetrvávat až tři týdny po instalaci.

Pro snížení intenzity vůně se doporučuje:

- v případě čalouněného nábytku - vysajte výrobek a vyvětrejte místnost.

Opakujte 3-4x denně.

- u skříňového nábytku - otřete hadříkem navlhčeným v jemném saponátu, otřete čistým suchým hadříkem a místnost vyvětrejte, nejprve otevřete všechna dvířka a zásuvky výrobku.

Opakujte 3-4x denně. Důležité! Návod si prosím uschovejte pro případ opětovné montáže nábytku nebo reklamaci.

Při reklamaci prosím použijte označení v návodu.

**VAROVÁNÍ!** Pád kusu nábytku může způsobit vážná nebo smrtelná zranění v důsledku rozdrčení. VŽDY upevněte tento kus nábytku ke stěně pomocí omezovačů. Zakotvený kolík se

používá pro cihlové a betonové stěny. Pro montáž na stěnu použijte spojovací materiál vhodný pro materiál stěny, pokud si nejste jisti, jaký typ upevnění je vhodný pro daný materiál stěny, obraťte se na odborníka nebo specializovanou prodejnu.





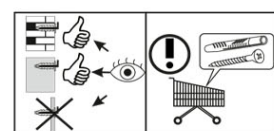
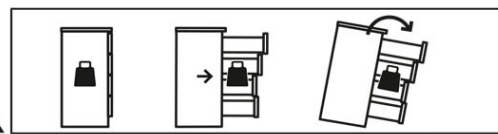

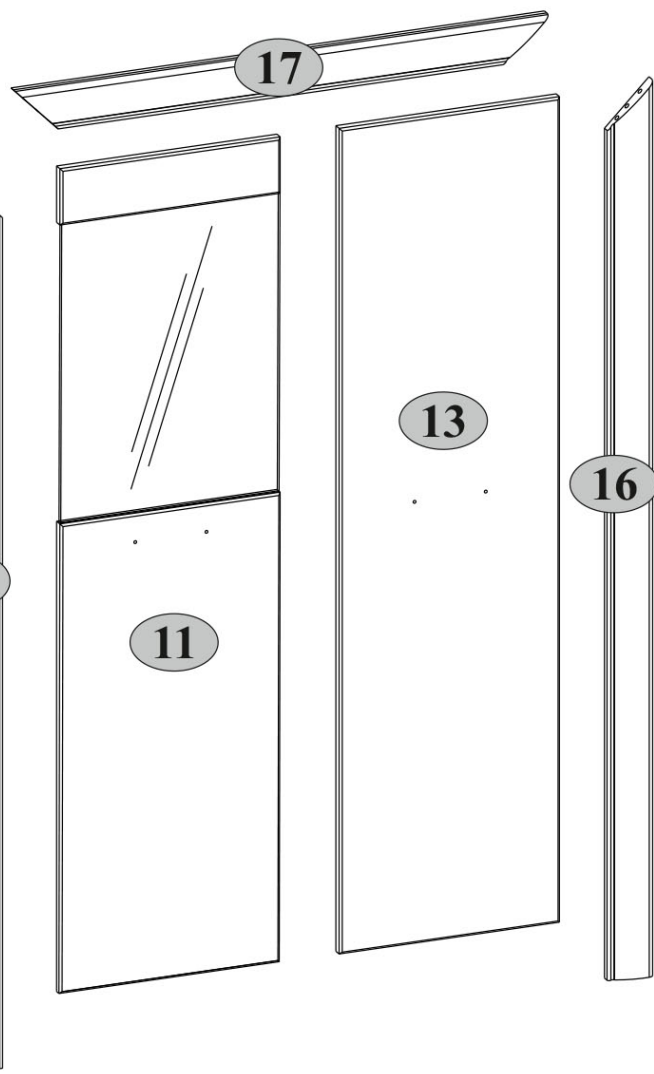
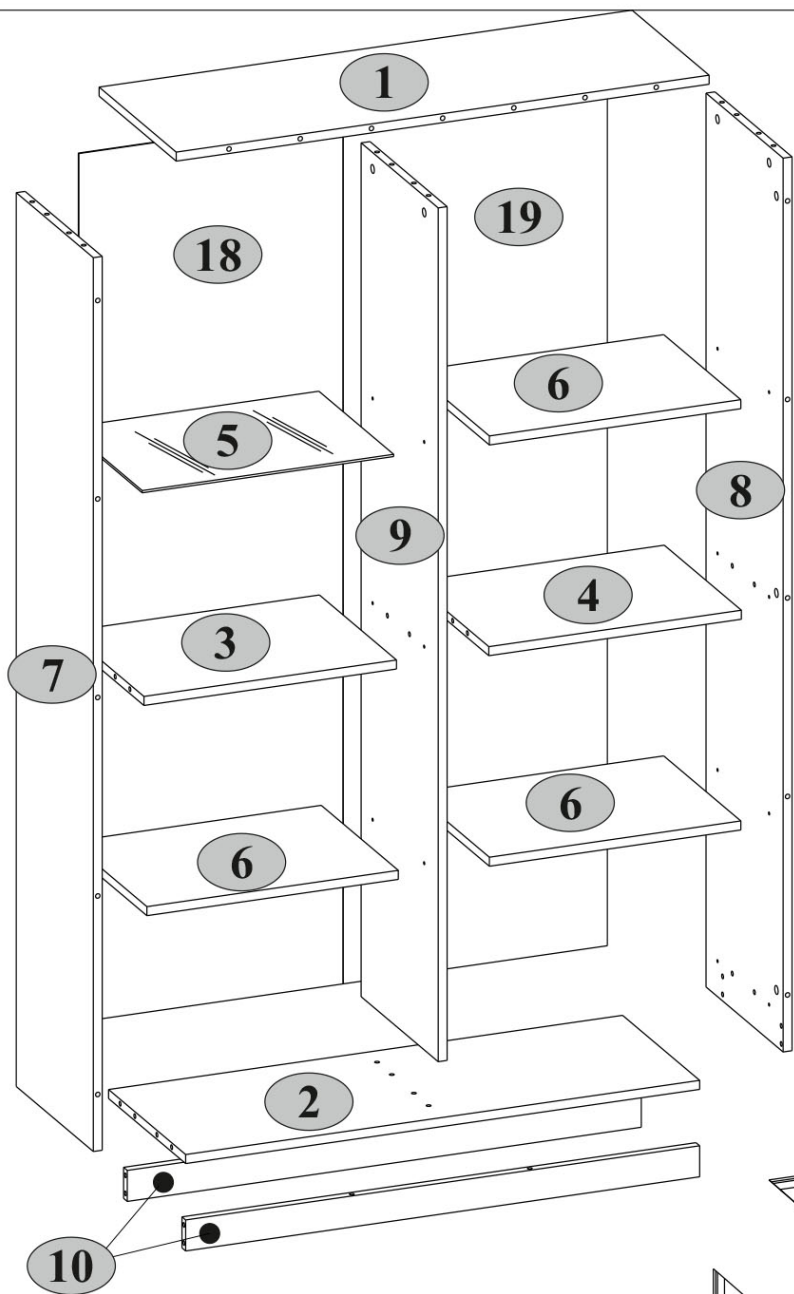

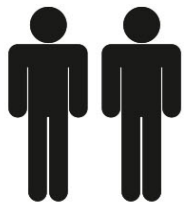





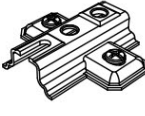
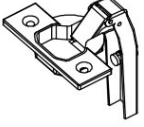
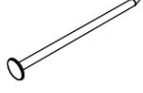



Konečnou odpovědnost za upevňovací prvky nese montér. Pro další snížení rizika vážných zranění a smrti v důsledku pádu nábytku:

- Nejtěžší předměty umístěte do spodní zásuvky.
- Nepokládejte na těžké předměty.
- Nikdy nedovolte dětem lézt na zásuvky, dvířka nebo police.
- Nábytek používejte k určenému účelu







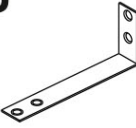
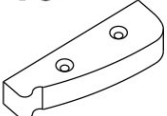

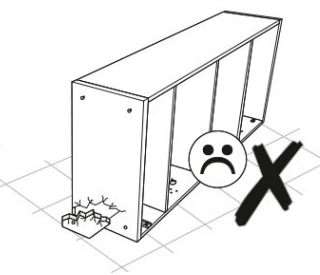
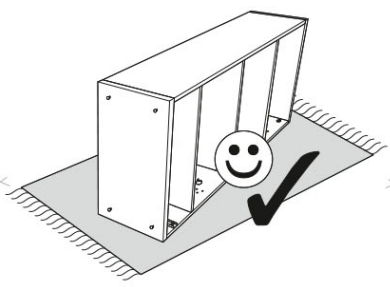
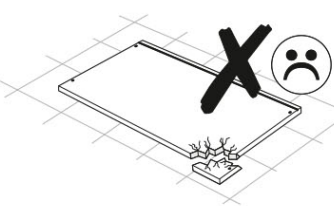
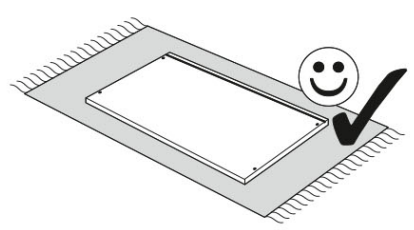
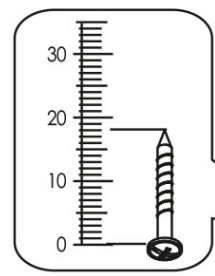
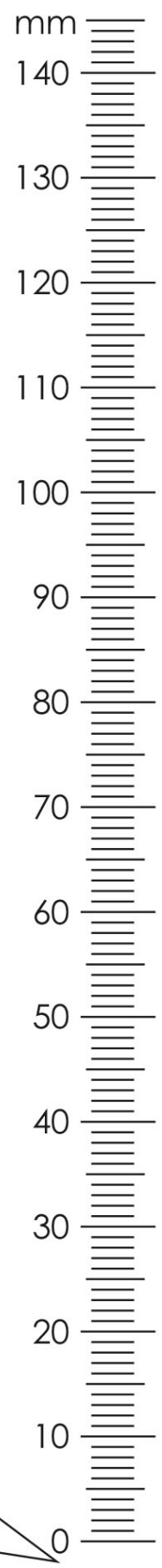
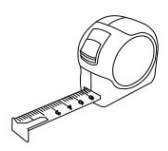
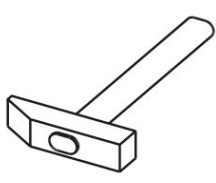
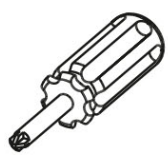
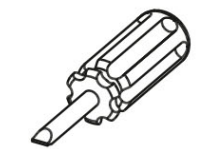



<b>A1.0</b>  5x28      28	<b>A2</b>  15x13      32	<b>A9</b>  L-47,4      2	<b>B5</b>  10x50      1
<b>C1</b>  8x35      43	<b>D1</b>  6	<b>E2</b>  6	<b>G</b>  1,5x26      40
<b>H63</b>  2	<b>I</b>  S4      1	<b>M4</b>  M4x22      4	<b>N1</b>  6
<b>P1</b>  Ø5      12	<b>P4</b>  4	<b>Q</b>  1,5x7      4	<b>R3</b>  3x20      5
<b>R5</b>  3x30      4	<b>R23</b>  6,3x13      12	<b>R24</b>  7x50      2	<b>R102</b>  3,5x16      14
<b>S3</b>  5	<b>S5</b>  Ø18      16	<b>U</b>  130x35x15      1	<b>V16</b>  80x25x15      2

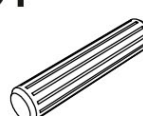



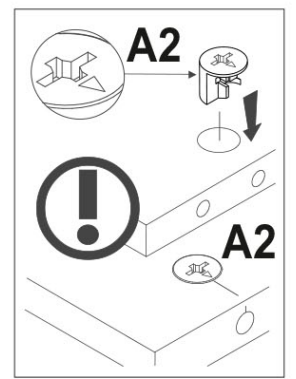
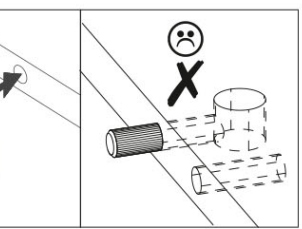
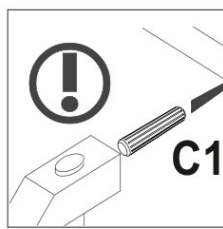
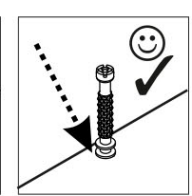
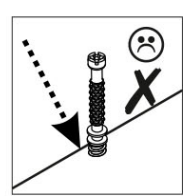
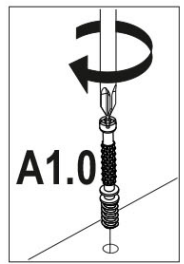
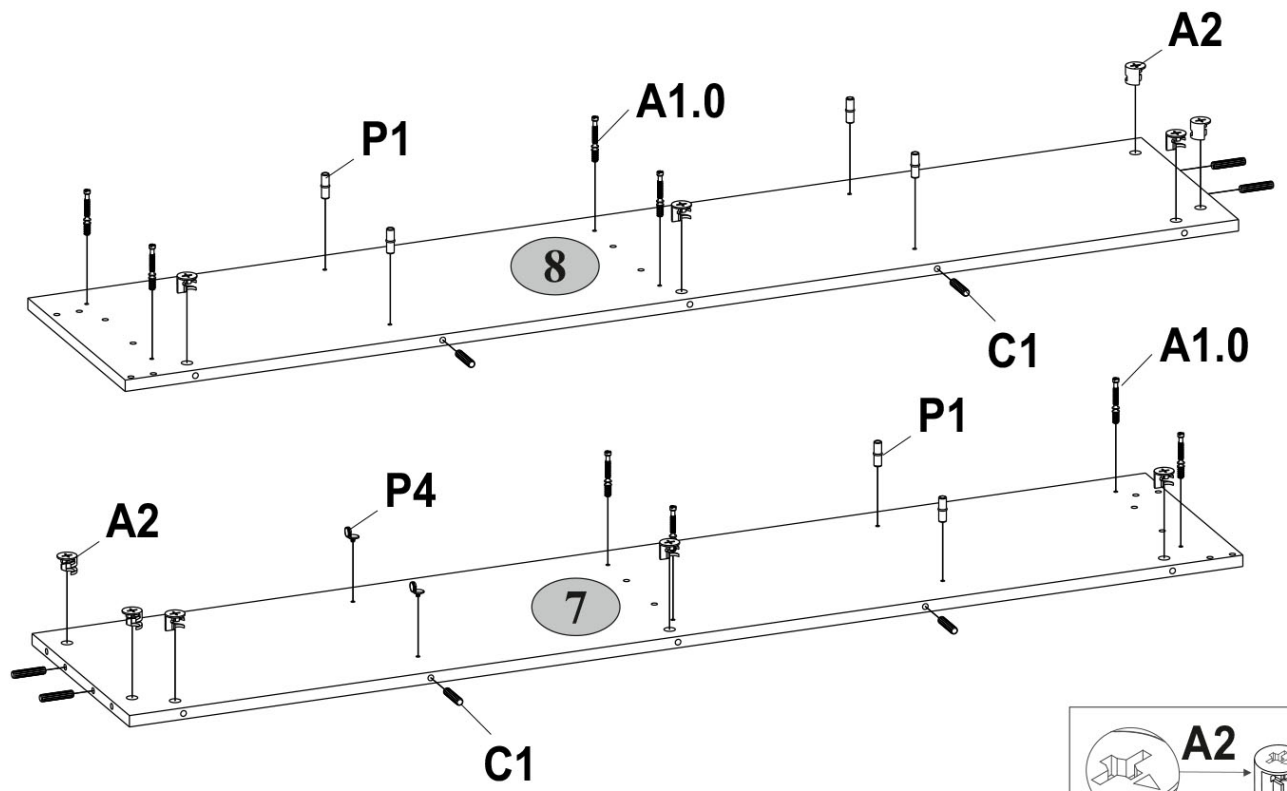

**1**

<b>A1.0</b>  5x28	<b>A2</b>  8 15x13	<b>C1</b>  10 8x35	<b>P1</b>  8 Ø5	<b>P4</b>  6	<b>P4</b>  2
--	---	---	---	---	---





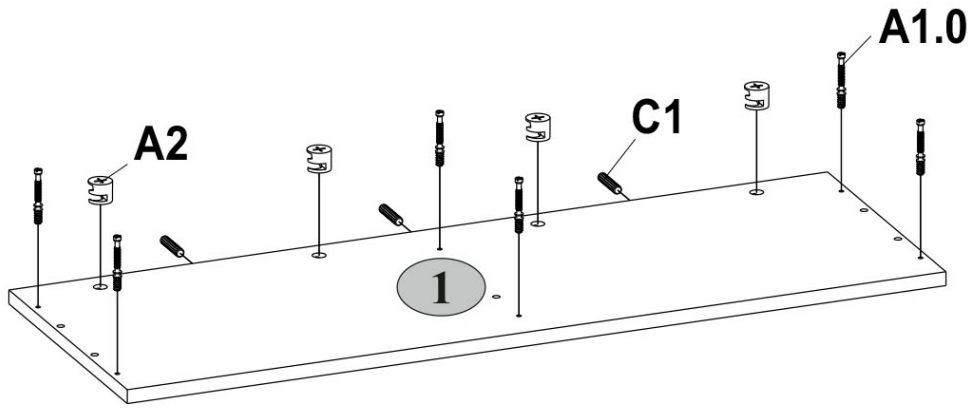

**2**

<b>A1.0</b>  5x28	<b>A2</b>  6 15x13	<b>C1</b>  4 8x35	<b>C1</b>  3
--	---	--	---





**3**

<b>A1.0</b>  5x28	<b>A2</b>  4 15x13	<b>C1</b>  2 8x35	<b>P1</b>  4 Ø5	<b>P4</b>  6 2
--	---	--	---	---

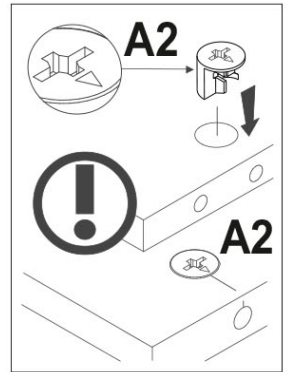
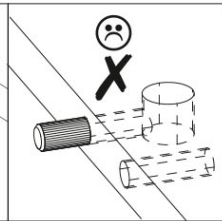
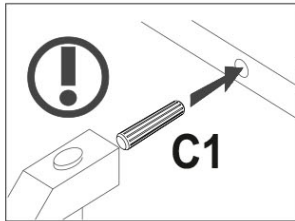
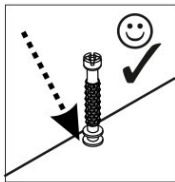
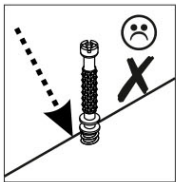
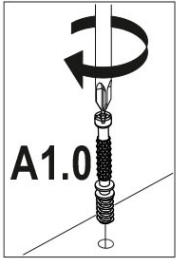
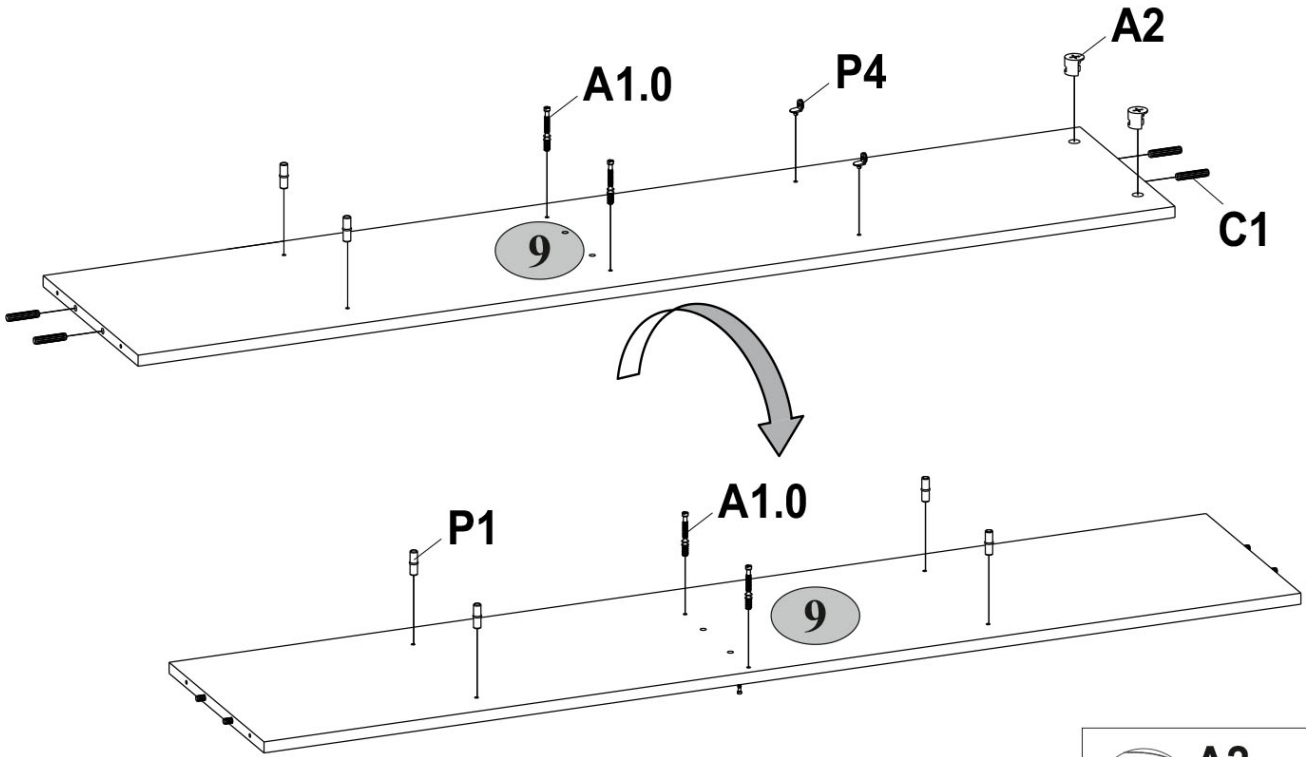

**4**

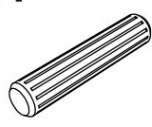
<b>A2</b>  15x13	<b>C1</b>  8 8x35
---	--

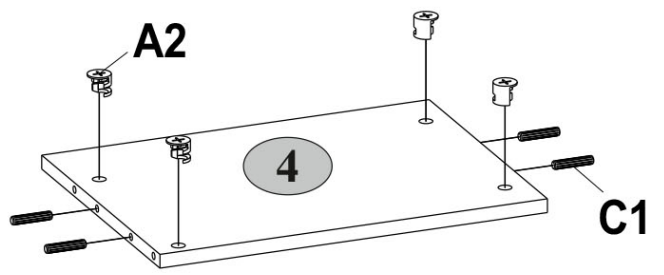
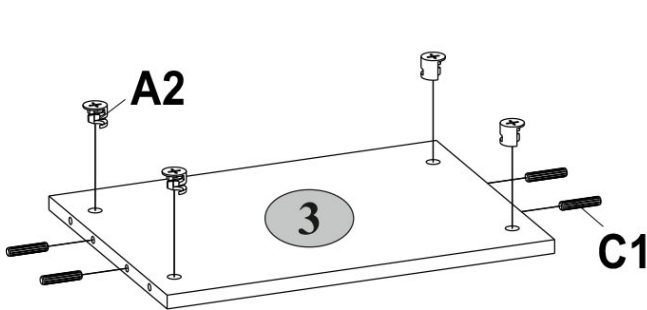

**5**

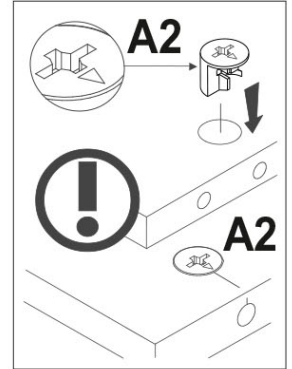
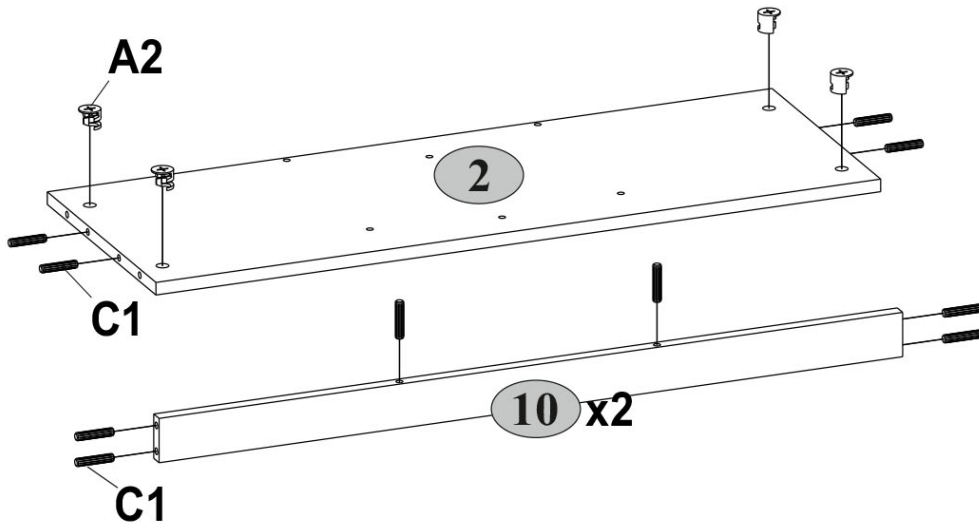
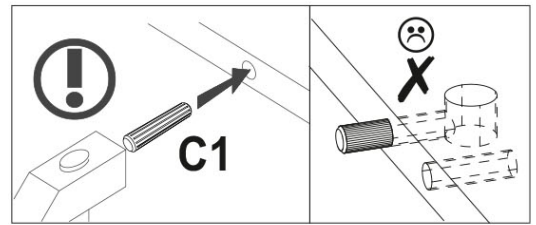
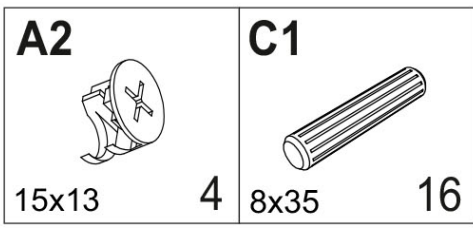

**6**

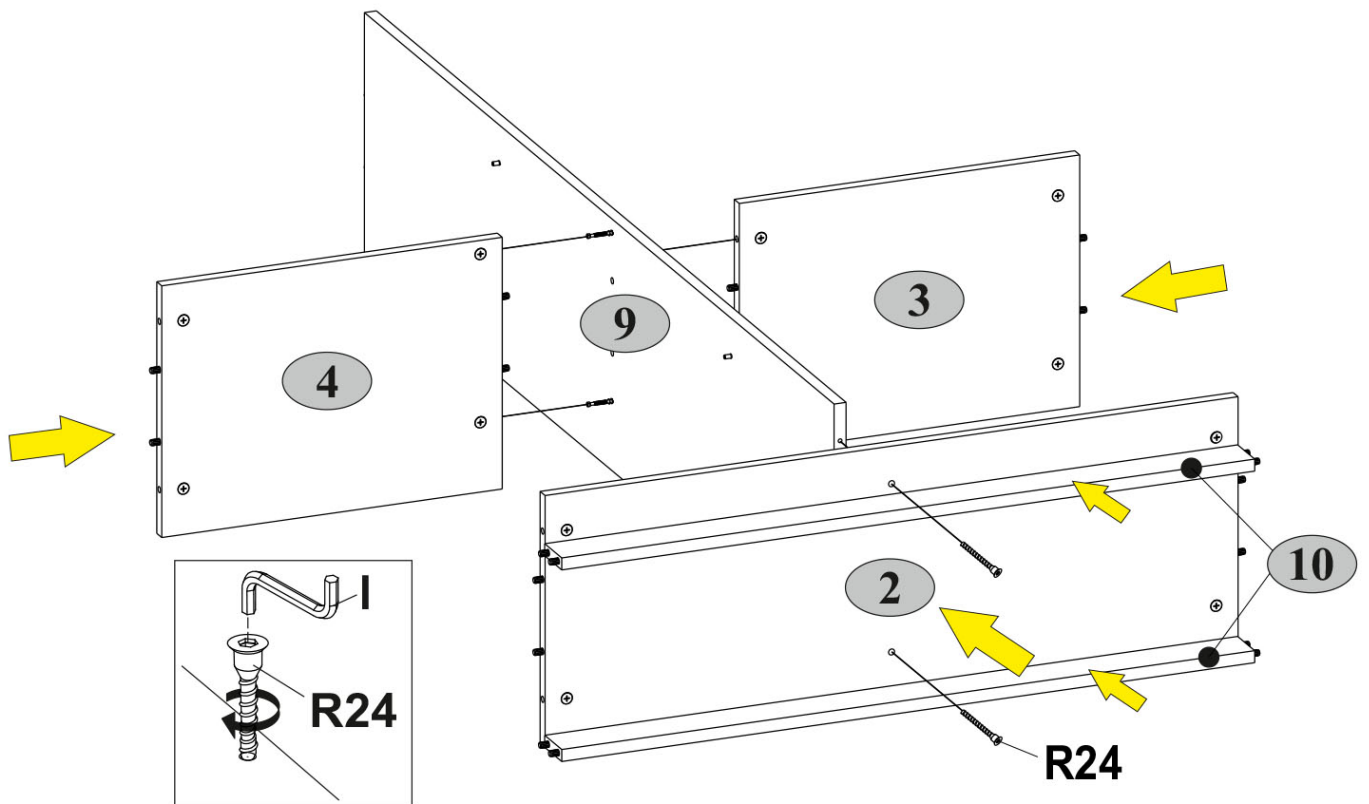
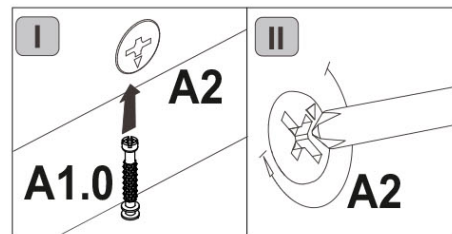
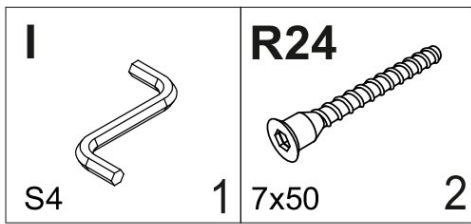

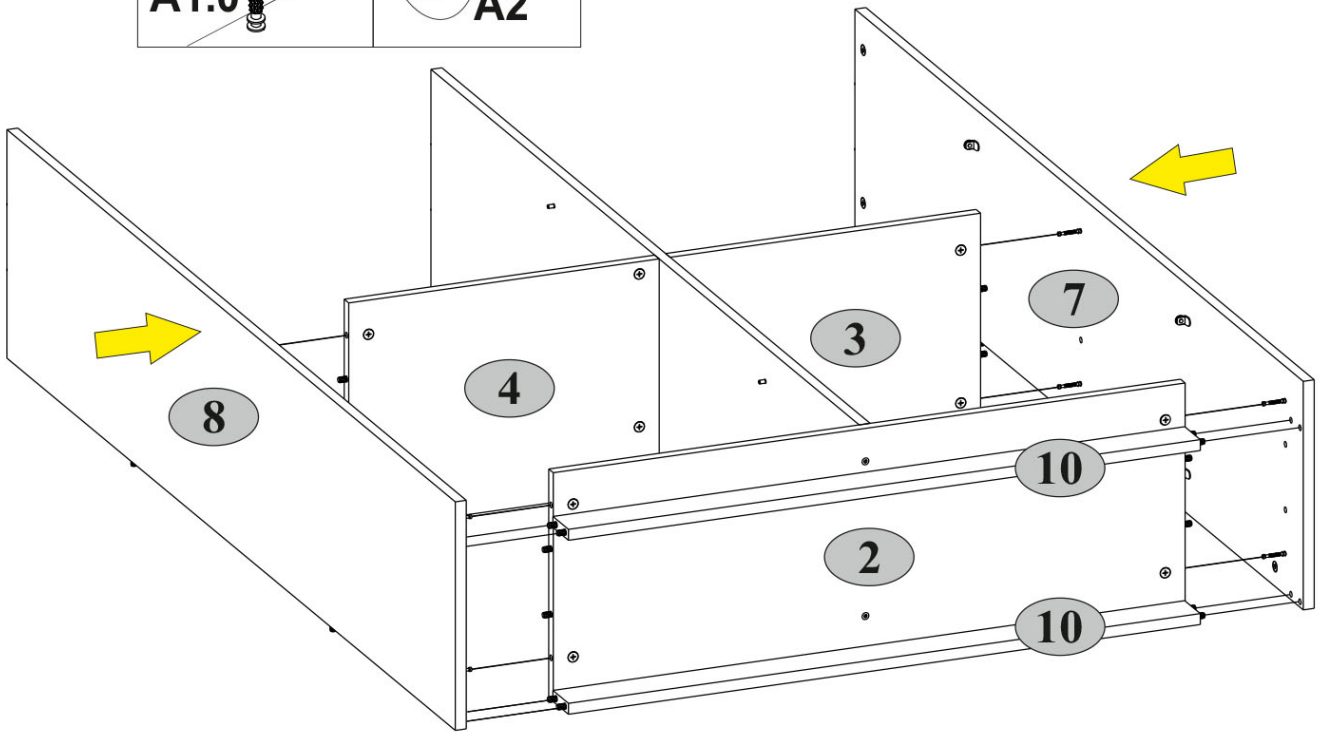
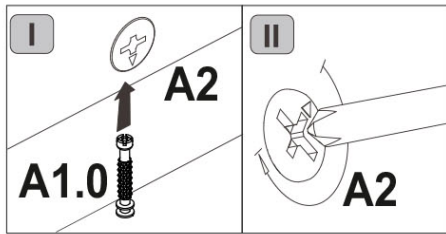

**7**

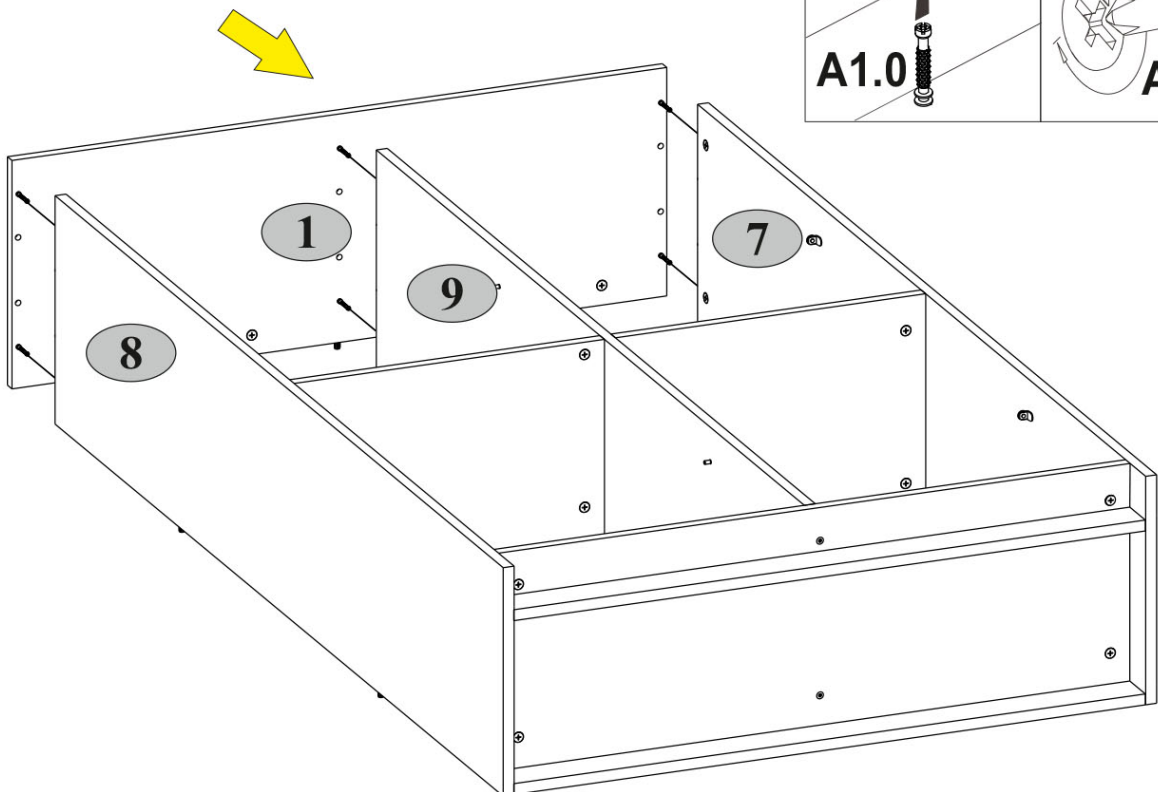
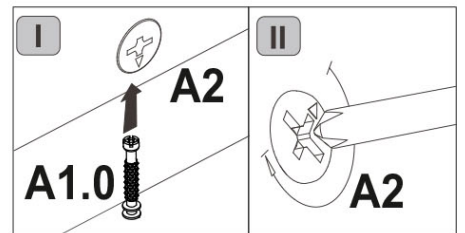

**8**





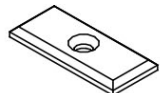

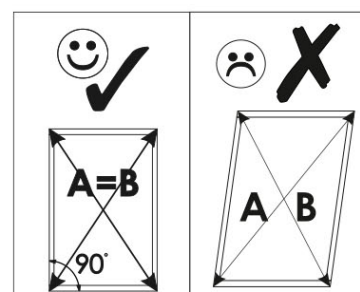
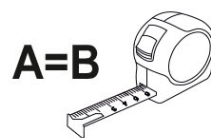
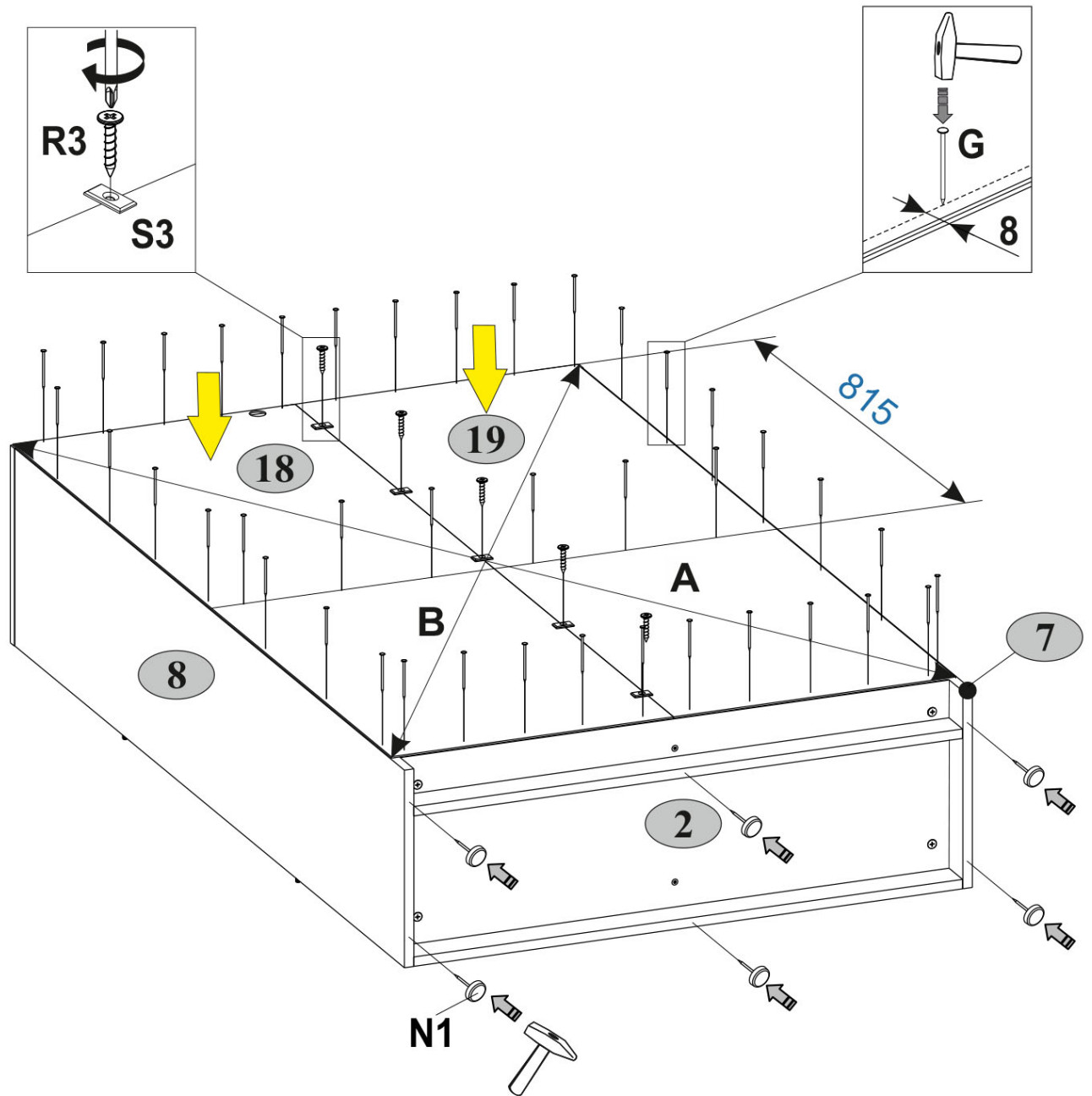
**9**

<b>G</b>  1,5x26    40	<b>N1</b>  6	<b>R3</b>  3x20    5	<b>S3</b>  5
---	---	---	--





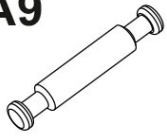
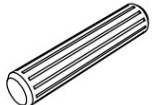
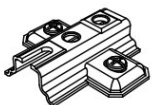

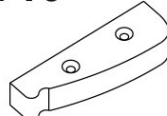

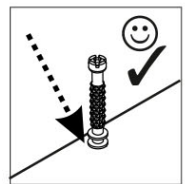
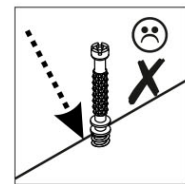
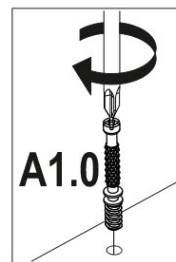
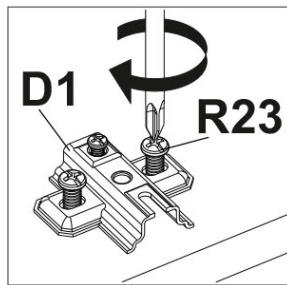
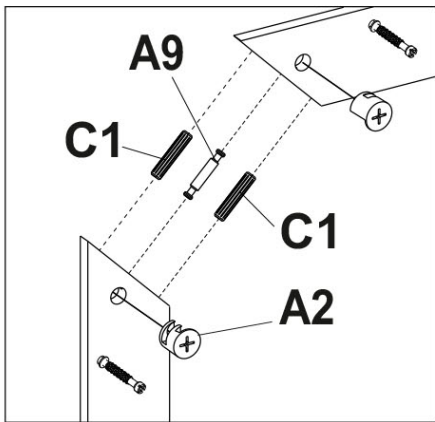
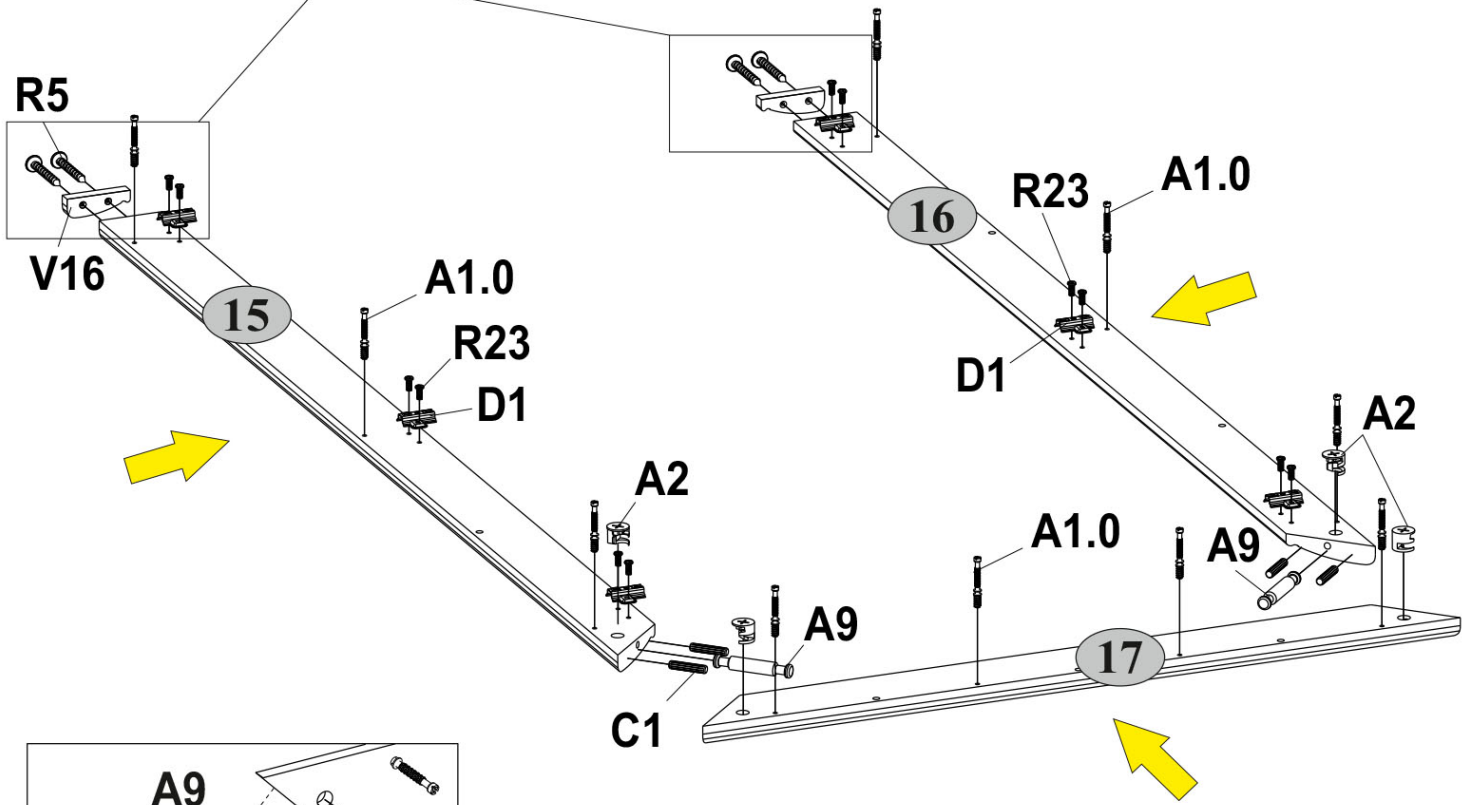
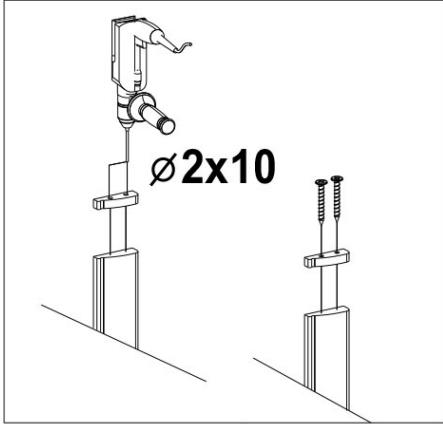
**10**

<b>A1.0</b>  5x28 10	<b>A2</b>  15x13 4	<b>A9</b>  L-47,4 2	<b>C1</b>  8x35 4	<b>D1</b>  6
<b>R5</b>  3x30 4	<b>R23</b>  6,3x13 12	<b>V16</b>  80x25x15 2		

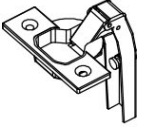

**11**

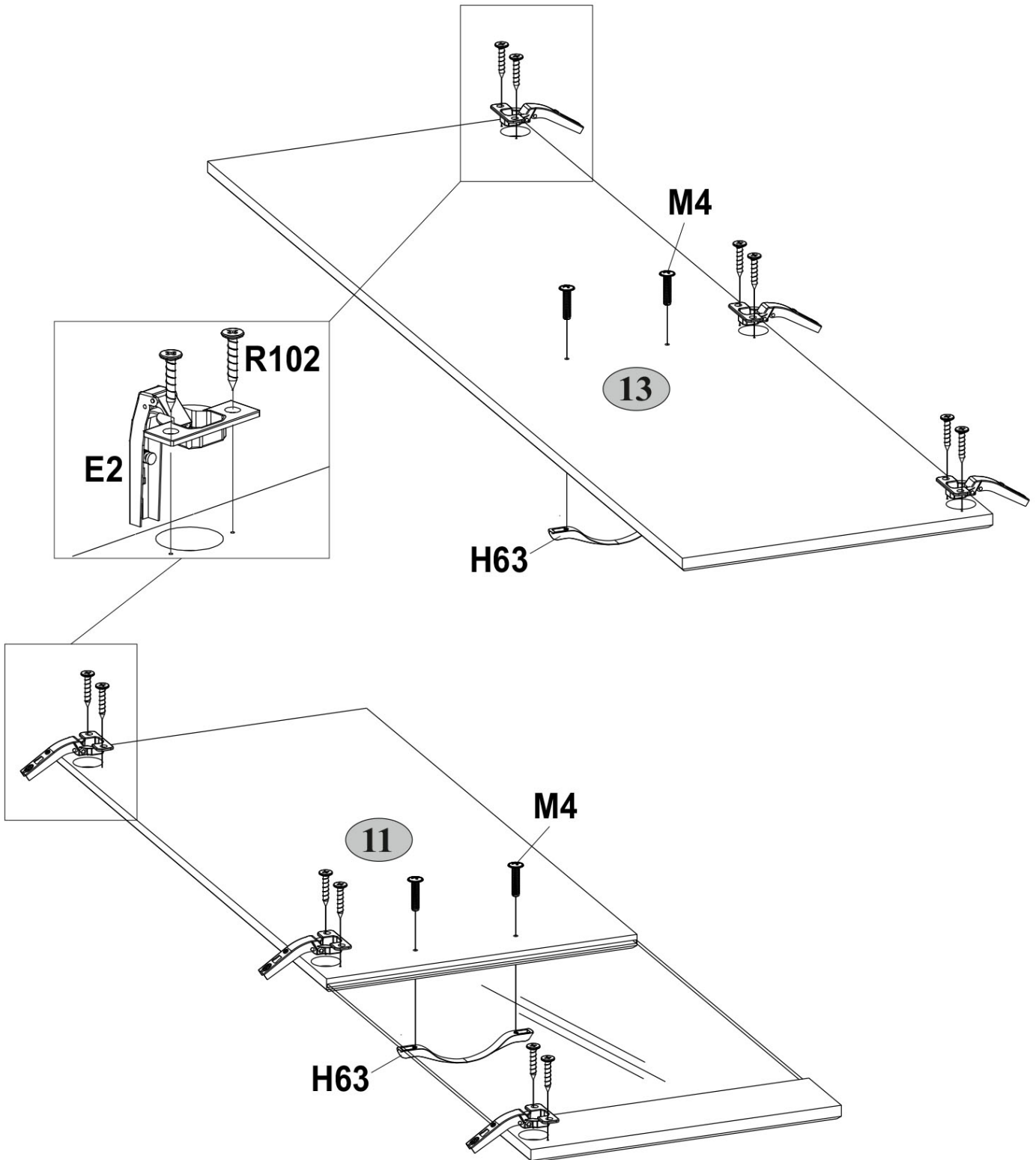

<b>E2</b>  6	<b>H63</b>  2	<b>M4</b>  M4x22 4	<b>R102</b>  3,5x16 12
---	--	---	---



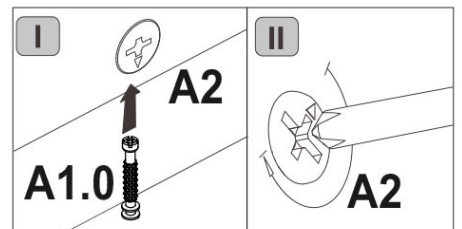
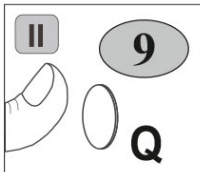
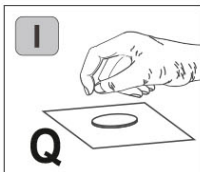
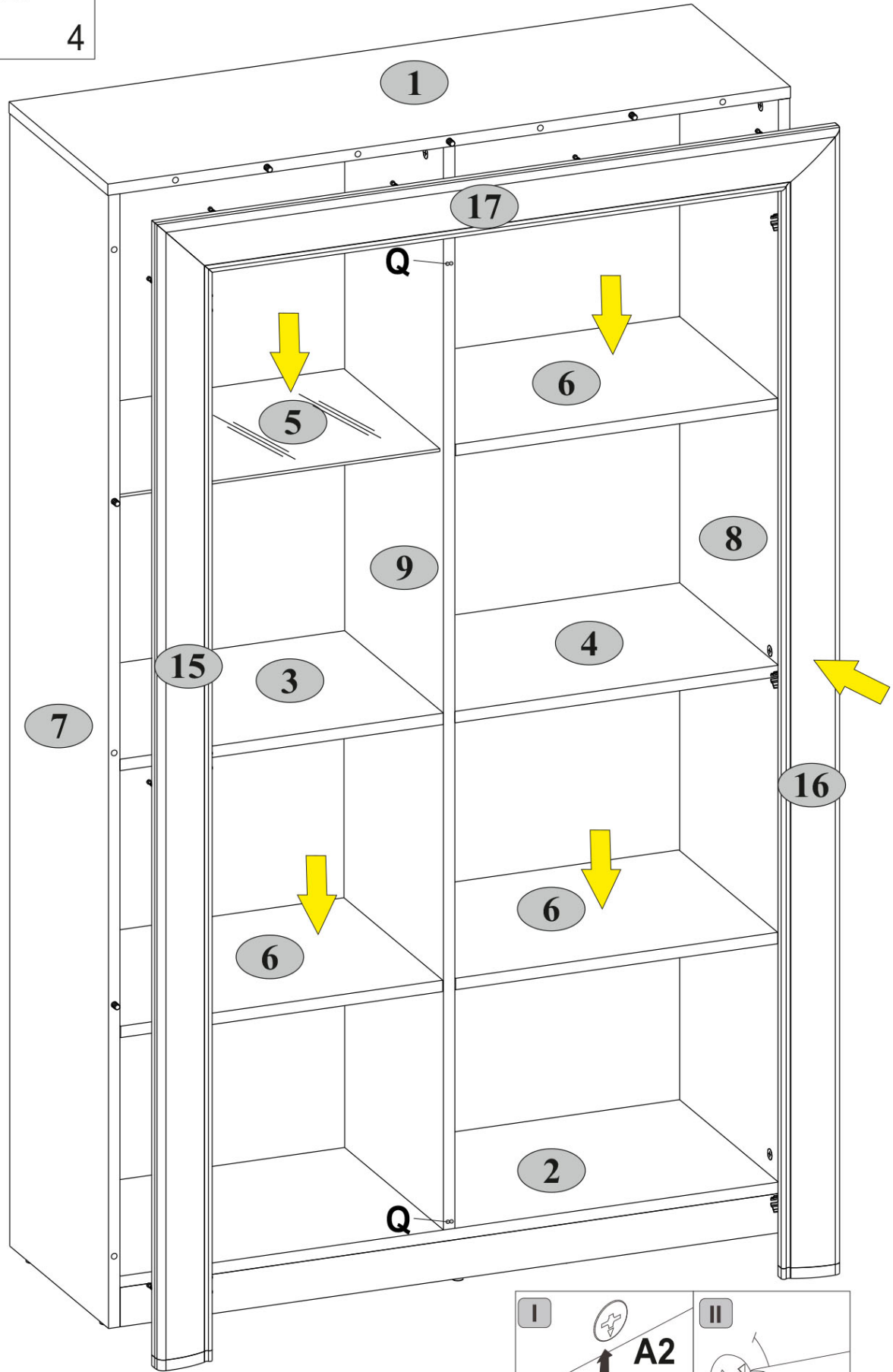
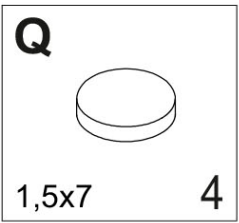



**12**

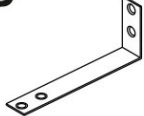

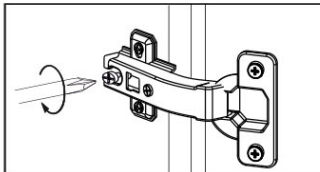
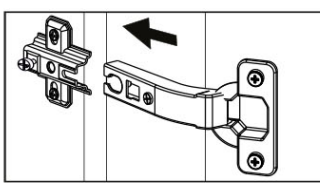
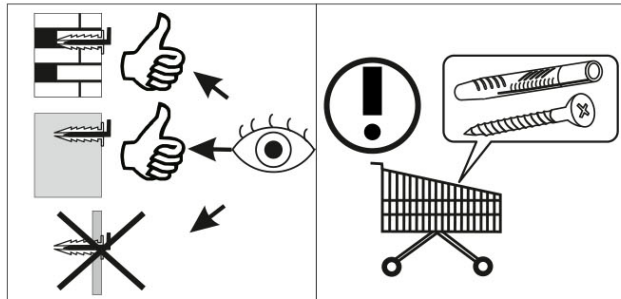
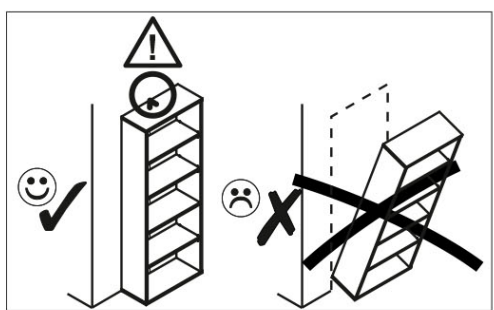
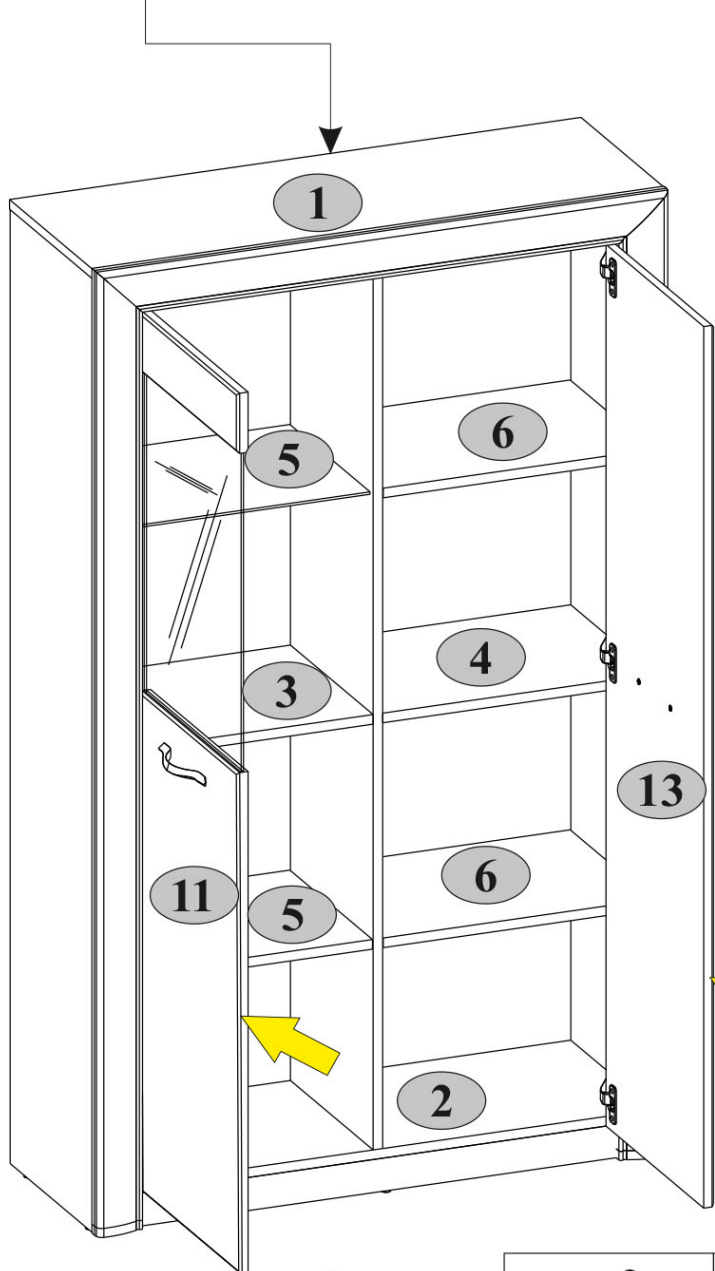
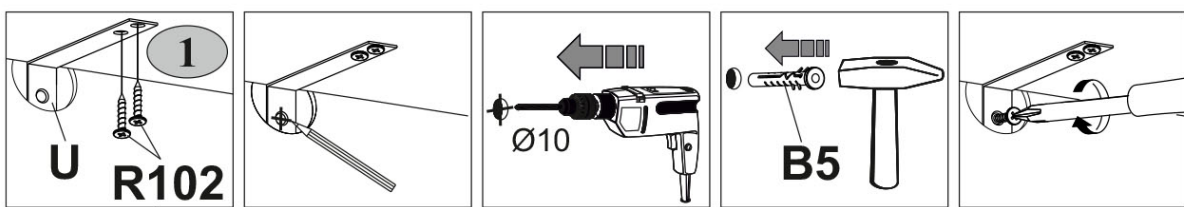
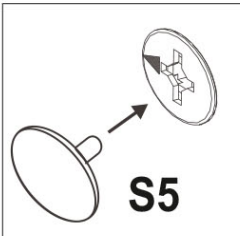
# 13

<b>B5</b>  10x50 1	<b>R102</b>  3,5x16 2	<b>S5</b>  Ø18 16	<b>U</b>  130x35x15 1
---	--	--	---



- 3 4 5 6**  max. 5 kg
- 1**  max. 10 kg
- 2**  max. 15 kg

